



FACILITAS



ITALIAN QUALITY

**STAINLESS STEEL
LOCKERS AND CUPBOARDS
FOR THE FOOD INDUSTRY**

TECHNICAL CATALOG

FACILITAS SRL

Via Lazio, 7

I-41050 Montale Rangone (Modena) - ITALY

Tel.: +39 (0)59 530.570

Fax: +39 (0)59 490.9000

Email: facilitas@facilitas.it

Web: www.facilitas.it



REV. 2014



AMADA
Vipros punch press



SALVAGNINI
P4 panel bender

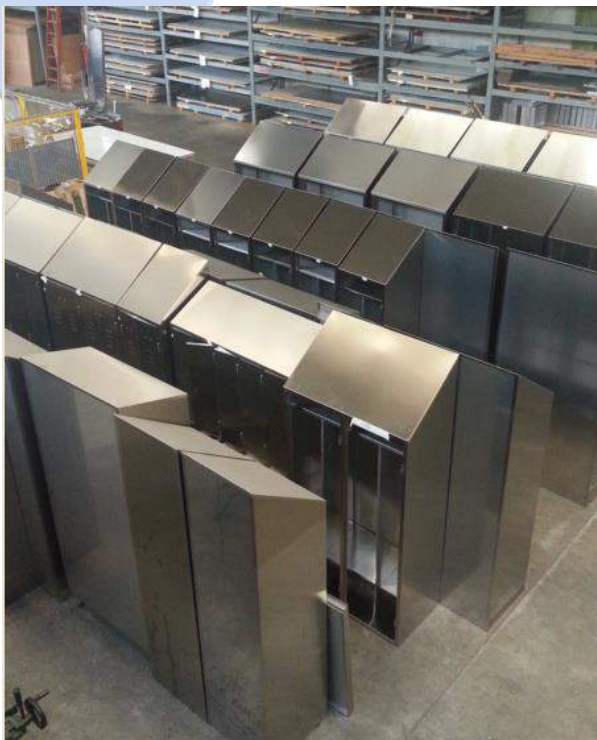

AUTOMATIC
Spot welding robot

FACILITAS IS STAINLESS STEEL

FACILITAS is an Italian based manufacturing company.

We design, manufacture and export stainless steel changing room lockers, broom and storage cupboards, stand-up desks and work tables in stainless steel for the food / food processing, dairy and pharmaceutical industry and large-scale supermarket trade.

We started business in the 1960s manufacturing metallic shelving and from the mid-1980s we started operating in the food processing sector with the production of furniture in stainless steel, becoming the first Italian manufacturer for stainless steel changing room lockers. Today our production capabilities have grown to almost 500 units per month. We work throughout Europe as well as in North and South America and in Australia.

Our customers benefit from our experience and attention to technological innovation. We have a complete offering of standard products but can also offer nonstandard bespoke products that respect our customers specific needs.



FACILITAS SRL

Via Lazio, 7

I-41050 Montale Rangone (Modena) – ITALY

Tel.: +39 (0)59 530.570

Fax: +39 (0)59 490.9000

Email: facilitas@facilitas.it

Web: www.facilitas.it



STAINLESS STEEL CHARACTERISTICS

STAINLESS STEEL, also known as inox steel or inox from the Italian word *inossidabile*, is a steel alloy with a minimum of 10.5% chromium content by mass.

APPLICATIONS

- Food processing equipment and furniture, particularly in the meat/fish/poultry processing, wine making and dairy industry.
- Professional kitchens, trough equipment and appliances (sinks, tables, fittings, railing, etc.).
- Architectural paneling, railings & trim.
- Food or chemical containers.

470LI-24Cr *Nickel free*

Belongs to the new generation of superferritic grade stainless steel. Produced by means of VOD (Vacuum Oxygen Decarburation). This particular production process ensures the achieving of excellent corrosion resistance comparable or superior to AISI 316 but at a fraction of the cost.

AISI 304

European norm 1.4301 is the most common austenitic stainless steel. Very good corrosion resistance makes this stainless steel the standard in the food industry.

AISI 441 *Nickel free*

European norm 1.4509 is a more common ferritic grade stainless steel. Good corrosion resistance, often comparable to that of general austenitic grade AISI 304 (1.4301). AISI 441 is the standard in the large-scale supermarket trade.

PREN - Pitting Resistance Equivalent Number	
Tipo Acciaio Stainless Grade	Resistenza alla corrosione Corrosion Resistance
470li-24Cr	24,50
316L	24,00
304	20,00
441	18,50
430	16,50

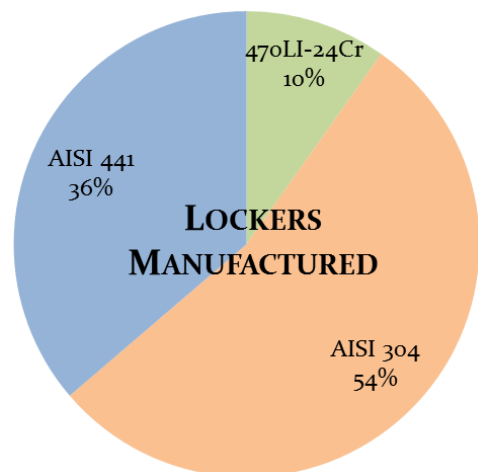

TABLE OF CONTENTS

	<p>CHANGING ROOM LOCKERS</p>
	<p>Page 6 - 11</p>

	<p>BROOM CABINETS MOP CABINETS EMPTY CABINETS</p>
	<p>Page 12 - 14</p>

	<p>STORAGE CUPBOARDS PC CUPBOARD BOOT STORAGE CUPBOARD</p>
	<p>Page 15 - 17</p>

	<p>STAND UP DESKS CHEST OF DRAWERS</p>
	<p>Page 18 - 20</p>

	<p>PIGEONHOLE LOCKERS PIGEONHOLE BENCHES BENCHES</p>
	<p>Page 21 - 27</p>

	<p>SLIDING DOOR STORAGE CUPBOARDS DISPENSERS</p>
	<p>Page 28 - 31</p>

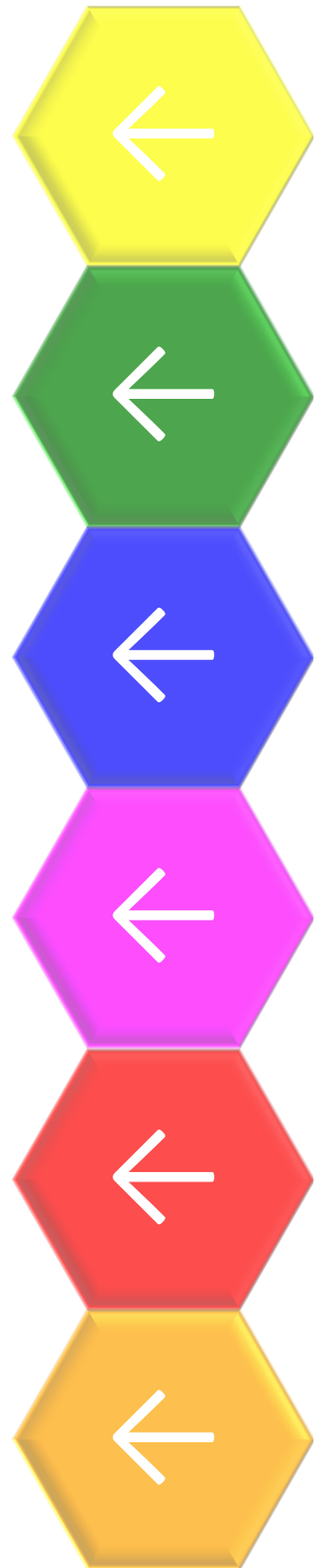

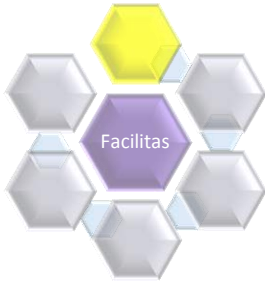

**CHANGING
ROOM
LOCKERS**

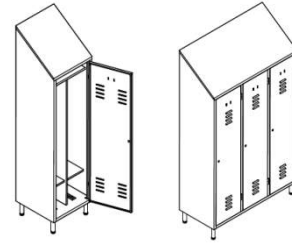

0,8 mm thick stainless steel brushed 2J finish (Scotch-Brite), dustproof slanting top, padlockable knob or key lock, adjustable screw on feet. Internal partition for dirty/clean clothes.

STANDARD

X1001

1 door, dirty / clean partition
mm 500 x 500 x 1800 / 2160 H

X1012

2 doors, dirty / clean partition
mm 950 x 500 x 1800 / 2160 H

X1014

3 doors, dirty / clean partition
mm 1200 x 500 x 1800 / 2160 H

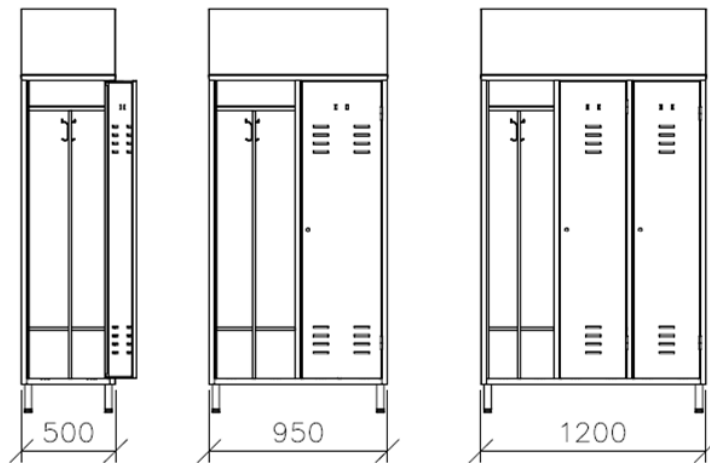

mm 500 deep

C400

C001E

1 door, dirty / clean partition
mm 500 x 400 x 1800 / 2000 H

C012E

2 doors, dirty / clean partition
mm 950 x 400 x 1800 / 2000 H

C014E

3 doors, dirty / clean partition
mm 1200 x 400 x 1800 / 2000 H

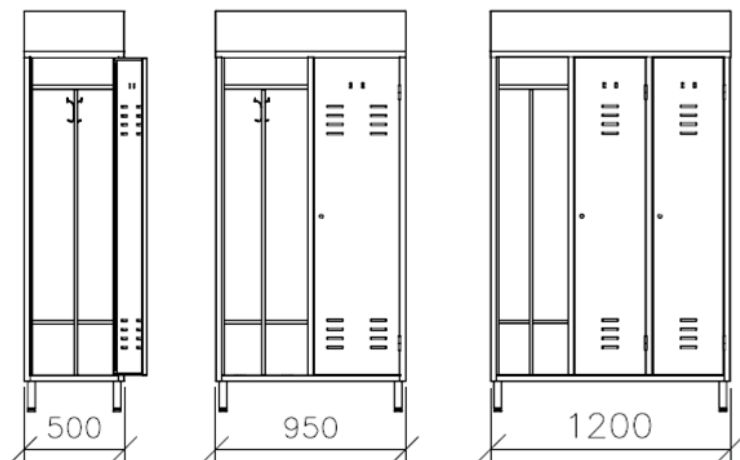

mm 400 deep

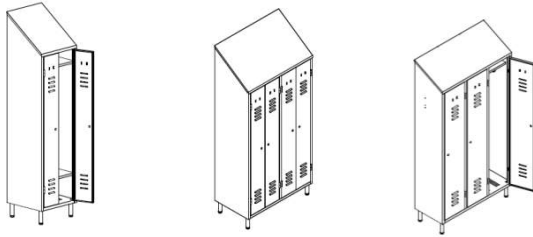

**CHANGING
ROOM
LOCKERS**

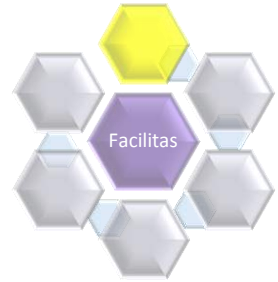

0,8 mm thick stainless steel brushed 2J finish (Scotch-Brite), dustproof slanting top, padlockable knob or key lock, adjustable screw on feet. Internal partition for dirty/clean clothes.

STANDARD

X1009

2 doors
mm 500 x 500 x 1800 / 2160 H

X1013

4 doors
mm 950 x 500 x 1800 / 2160 H

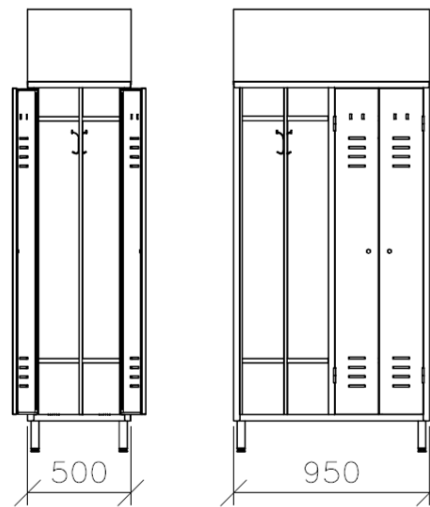

mm 500 deep

EASY SERIES

X1ED1

1 door, dirty / clean partition
mm 325 x 400 x 1800 / 2000 H

X1ED2

2 doors, dirty / clean partition
mm 615 x 400 x 1800 / 2000 H

X1ED3

3 doors, dirty / clean partition
mm 910 x 400 x 1800 / 2000 H

X1ED4

4 doors, dirty / clean partition
mm 1200 x 400 x 1800 / 2000 H

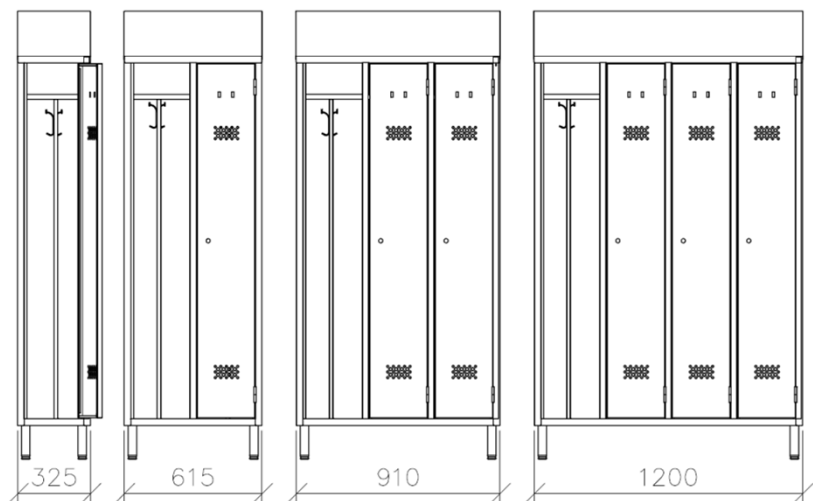

mm 400 deep

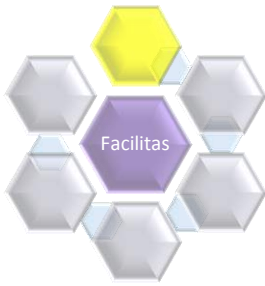

**CHANGING
ROOM
LOCKERS**

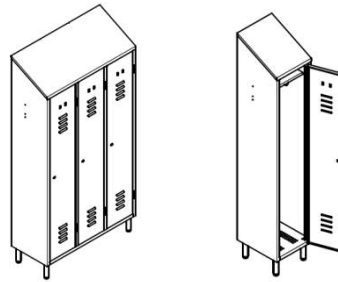

0,8 mm thick stainless steel brushed 2J finish (Scotch-Brite), dustproof slanting top, padlockable knob or key lock, internal top shelf, adjustable screw on feet.

EASY SERIES

X1E1

1 door

mm 325 x 400 x 1800 / 2000 H

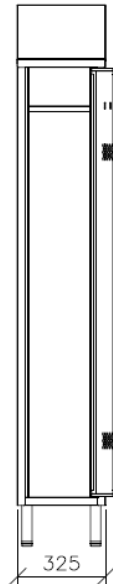

X1E2

2 doors

mm 615 x 400 x 1800 / 2000 H

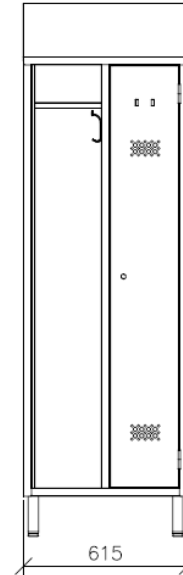

X1E3

3 doors

mm 910 x 400 x 1800 / 2000 H

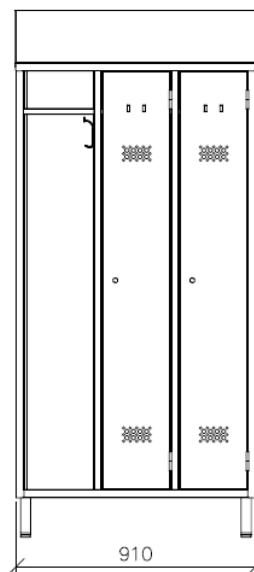

X1E4

4 doors

mm 1200 x 400 x 1800 / 2000 H

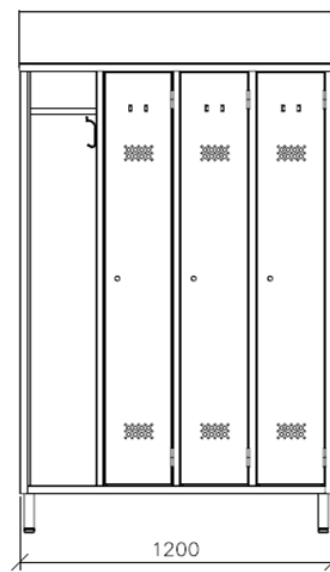

Standard door ventilation

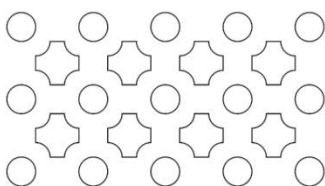

mm 400 deep

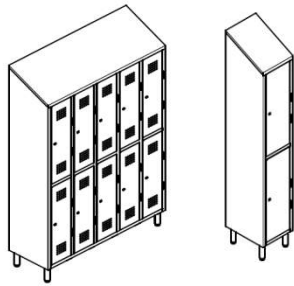

**CHANGING
ROOM
LOCKERS**

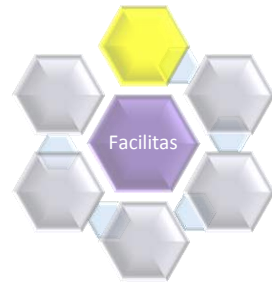

0,8 mm thick stainless steel brushed 2J finish (Scotch-Brite), dustproof slanting top, padlockable knob or key lock, adjustable screw on feet.

EASY MULTIPLE 2 TIER LOCKERS

X1E1-2

1 column, 2 tier (doors)
mm 325 x 400 x 1800 / 2000 H

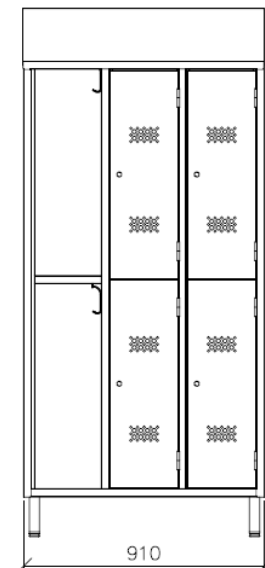
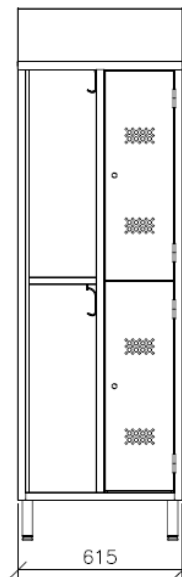
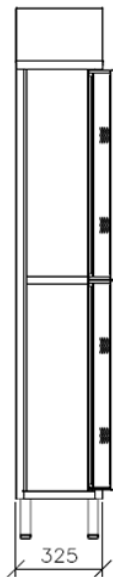

X1E2-4

2 columns, 4 tier (doors)
mm 615 x 400 x 1800 / 2000 H

X1E3-6

3 columns, 6 tier (doors)
mm 910 x 400 x 1800 / 2000 H

X1E4-8

4 columns, 8 tier (doors)
mm 1200 x 400 x 1800 / 2000 H

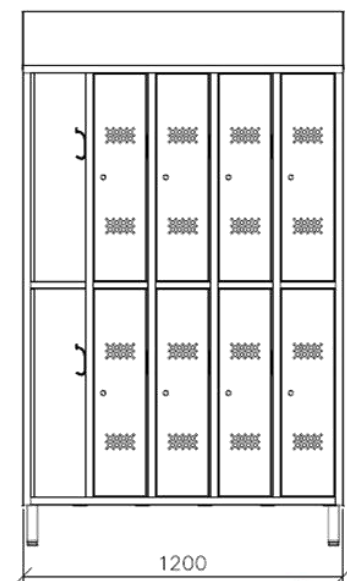
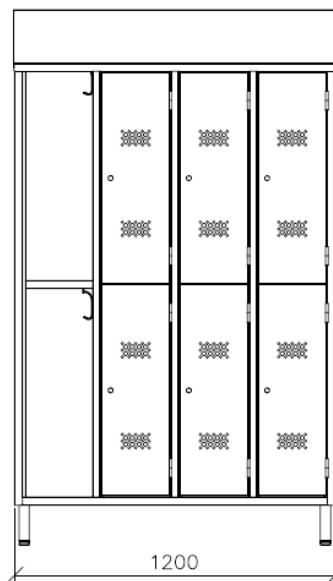

X1E4-10

5 columns, 10 tier (doors)
mm 1200 x 400 x 1800 / 2000 H

mm 400 deep

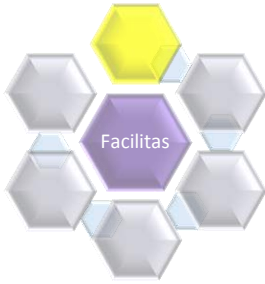

**CHANGING
ROOM
LOCKERS**

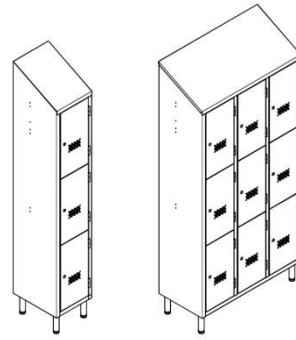

0,8 mm thick stainless steel brushed 2J finish (Scotch-Brite), dustproof slanting top, padlockable knob or key lock, adjustable screw on feet.

EASY MULTIPLE 3 TIER LOCKERS

X1E1-3

1 column, 3 tier (doors)
mm 325 x 400 x 1800 / 2000 H

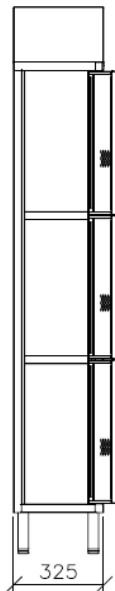

X1E2-6

2 columns, 6 tier (doors)
mm 615 x 400 x 1800 / 2000 H

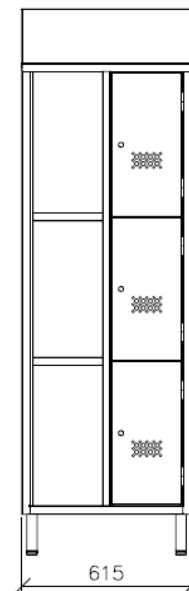

X1E3-9

3 columns, 9 tier (doors)
mm 910 x 400 x 1800 / 2000 H

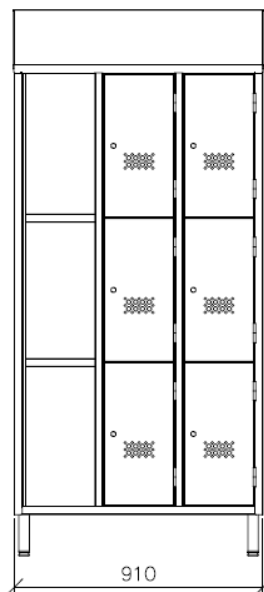

X1E4-12

4 columns, 12 tier (doors)
mm 1200 x 400 x 1800 / 2000 H

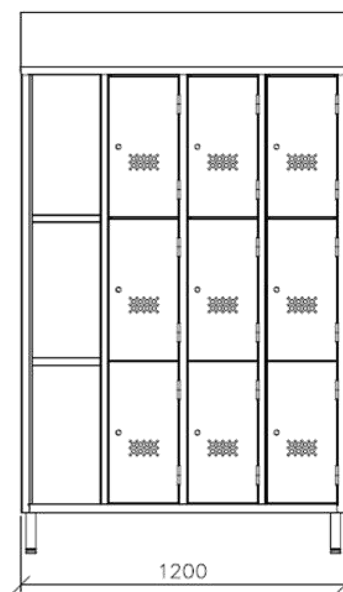

Standard door ventilation

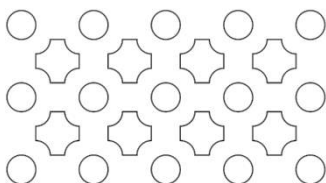

mm 400 deep

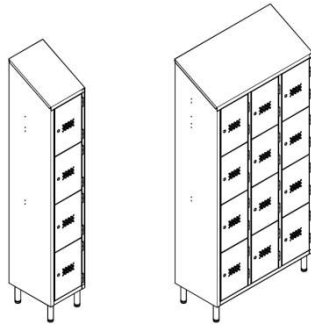

**CHANGING
ROOM
LOCKERS**

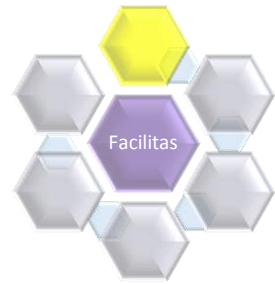

0,8 mm thick stainless steel brushed 2J finish (Scotch-Brite), dustproof slanting top, padlockable knob or key lock, adjustable screw on feet.

EASY MULTIPLE 4 TIER LOCKERS

X1E1-4

1 column, 4 tier (doors)
mm 325 x 400 x 1800 / 2000 H

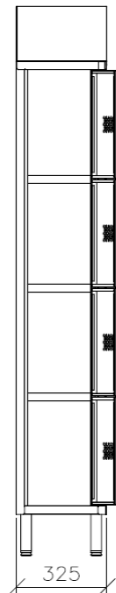

X1E2-8

2 columns, 8 tier (doors)
mm 615 x 400 x 1800 / 2000 H

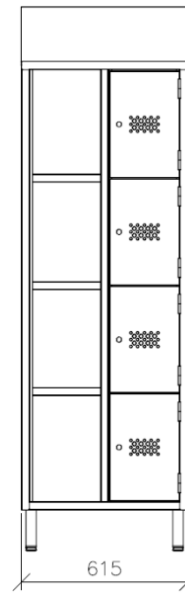

X1E3-12

3 columns, 12 tier (doors)
mm 910 x 400 x 1800 / 2000 H

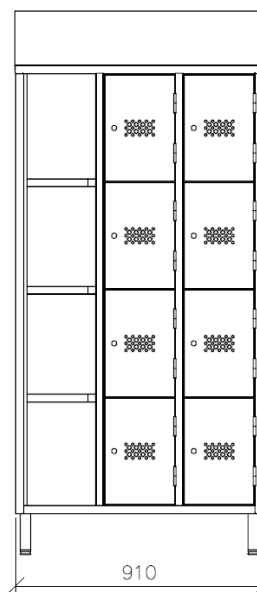

X1E4-16

4 columns, 16 tier (doors)
mm 1200 x 400 x 1800 / 2000 H

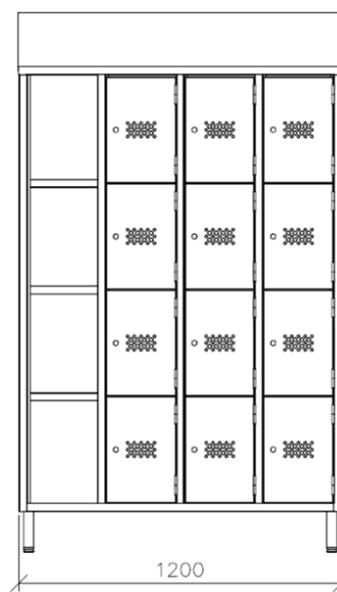

Standard door ventilation

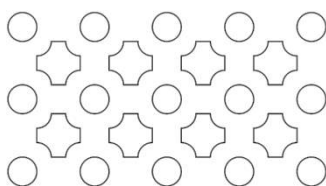

mm 400 deep



BROOM STORAGE CABINET
MOP STORAGE CABINET
EMPTY CABINETS

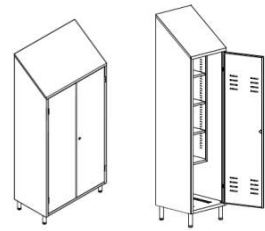

0,8 mm thick stainless steel brushed 2J finish (Scotch-Brite), dustproof slanting top, handle lock with key, adjustable screw on feet.
 One side for brooms/mops, one side for storage with shelves.

BROOM - STANDARD

X2010

1 door, internal vertical partition
 mm 500 x 500 x 1800 / 2160 H

X2002

2 doors, internal vertical partition
 mm 950 x 500 x 1800 / 2160 H

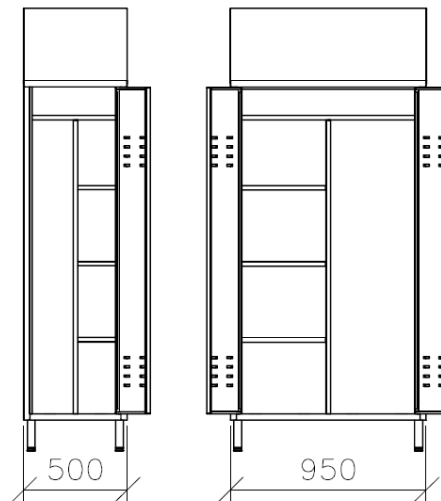

MOPS - STANDARD

X2013

1 door, internal vertical partition
 mm 500 x 500 x 1800 / 2160 H

X2014

1 door, internal vertical partition
 mm 600 x 500 x 1800 / 2160 H

X2012

2 doors, internal vertical partition
 mm 950 x 500 x 1800 / 2160 H



mm 500 deep

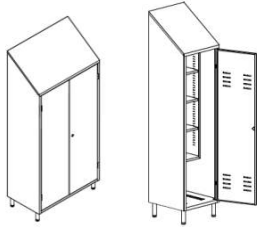

BROOM STORAGE CABINET
MOP STORAGE CABINET
EMPTY CABINETS

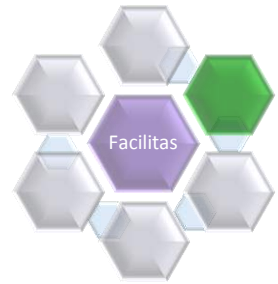

0,8 mm thick stainless steel brushed 2J finish (Scotch-Brite), dustproof slanting top, handle lock with key, adjustable screw on feet.
 One side for brooms/mops, one side for storage with shelves.

BROOM - C400

C2010E
 1 door, internal vertical partition
 mm 500 x 400 x 1800 / 2000 H

C002E
 2 doors, internal vertical partition
 mm 950 x 400 x 1800 / 2000 H



YouTube

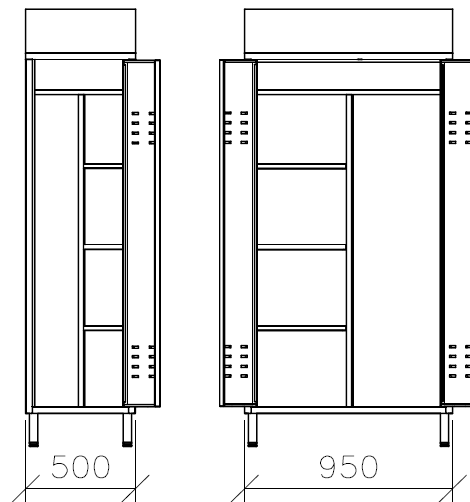

MOPS - C400

C2013E
 1 door, internal vertical partition
 mm 500 x 400 x 1800 / 2000 H

C2012E
 2 doors, internal vertical partition
 mm 950 x 400 x 1800 / 2000 H

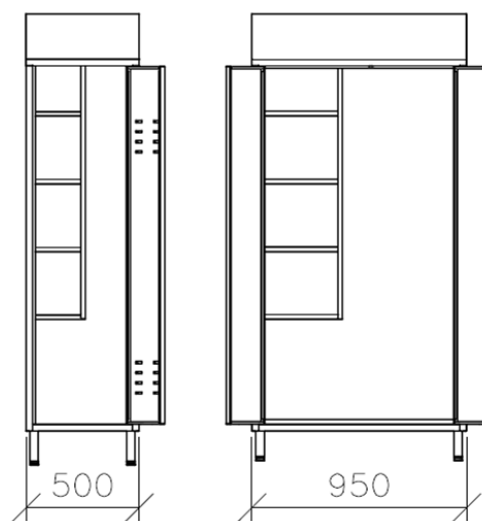

mm 400 deep



BROOM STORAGE CABINET
MOP STORAGE CABINET
EMPTY CABINETS

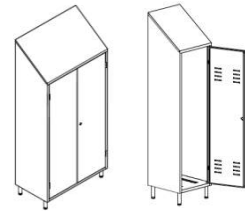

0,8 mm thick stainless steel brushed 2J finish (Scotch-Brite), dustproof slanting top, handle lock with key, adjustable screw on feet.
 Inside empty but with side shelf support racks for eventual shelf positioning.

EMPTY - STANDARD

X2011

1 door, empty on the inside
 mm 500 x 500 x 1800 / 2160 H

X2016

2 doors, empty on the inside
 mm 950 x 500 x 1800 / 2160 H

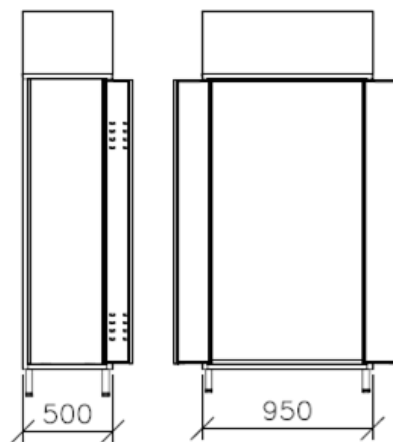

mm 500 deep

EMPTY - C400

C2011E

1 door, empty on the inside
 mm 500 x 400 x 1800 / 2000 H

C2016E

2 doors, empty on the inside
 mm 950 x 400 x 1800 / 2000 H

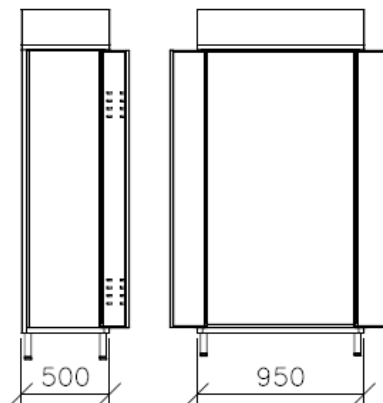

mm 400 deep

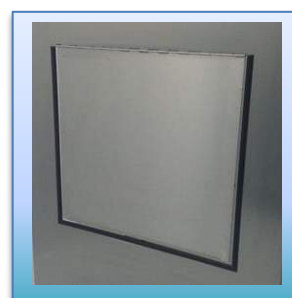
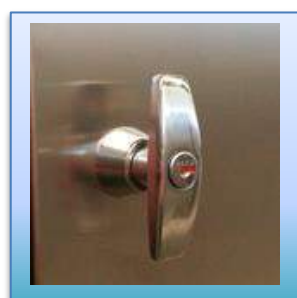

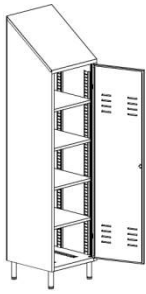

STORAGE CUPBOARDS
PC CUPBOARD
BOOT STORAGE CUPBOARD

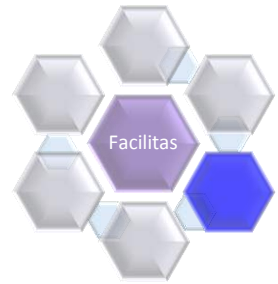

0,8 mm thick stainless steel brushed 2J finish (Scotch-Brite), dustproof slanting top, handle lock with key, 4 adjustable reinforced shelves, adjustable screw on feet.

STORAGE CUPBOARDS – STANDARD

X2004

1 door, 4 adjustable shelves
 mm 500 x 500 x 1800 / 2160 H

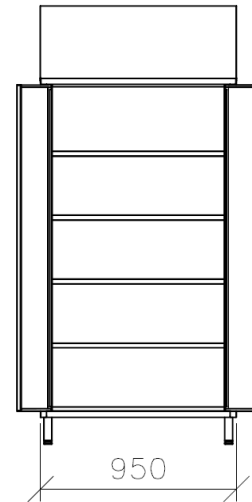
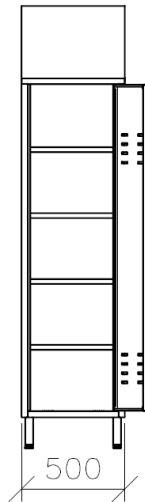

X2003

2 door, 4 adjustable shelves
 mm 950 x 500 x 1800 / 2160 H



X2017

2 door, 4 adjustable shelves
 mm 1200 x 500 x 1800 / 2160 H

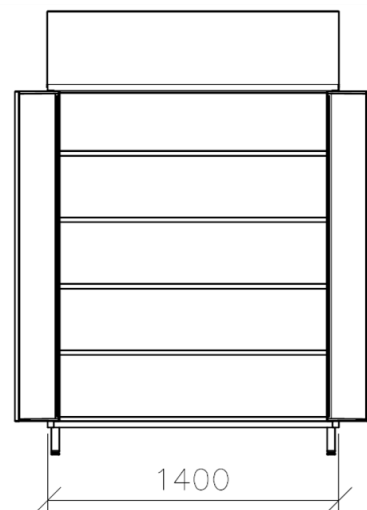
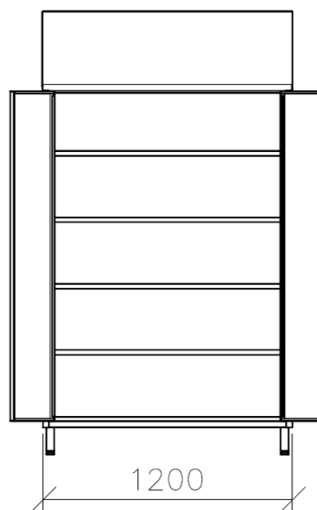

X2018

2 door, 4 adjustable shelves
 mm 1400 x 500 x 1800 / 2160 H

mm 500 deep

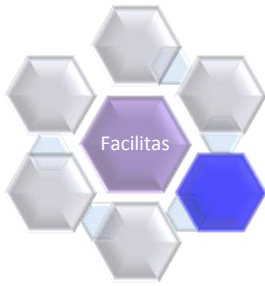

STORAGE CUPBOARDS

PC CUPBOARD

BOOT STORAGE CUPBOARD

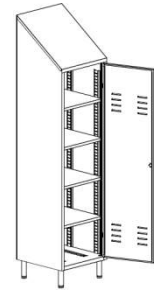

0,8 mm thick stainless steel brushed 2J finish (Scotch-Brite), dustproof slanting top, handle lock with key, 4 adjustable reinforced shelves, adjustable screw on feet.

STORAGE CUPBOARDS - C400

C004E

1 door, 4 adjustable shelves
mm 500 x 400 x 1800 / 2000 H

C003E

2 door, 4 adjustable shelves
mm 950 x 400 x 1800 / 2000 H

C017E

2 door, 4 adjustable shelves
mm 1200 x 400 x 1800 / 2000 H

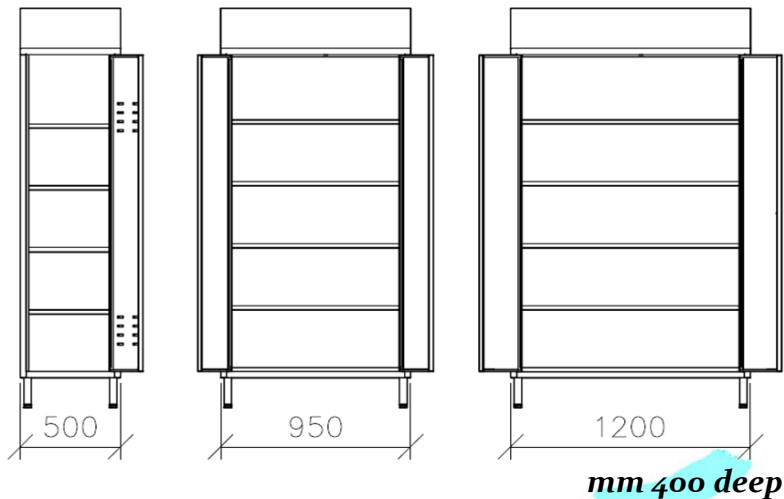

mm 400 deep

PC CUPBOARD

X2003-PC

2 doors, 1 drawer for keyboard
mm 600 x 520 x 1800 H

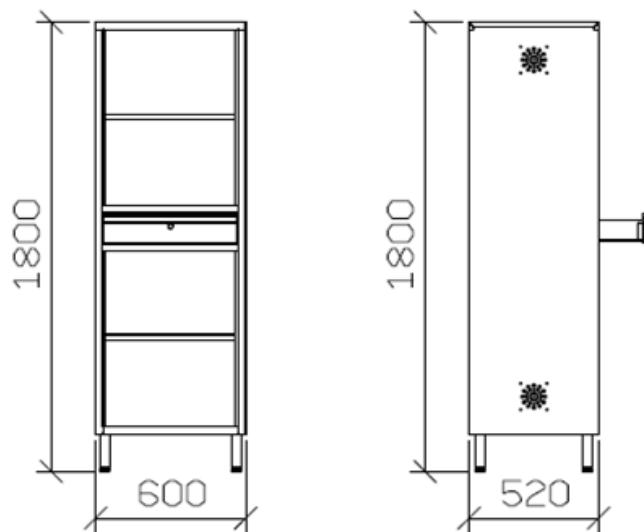
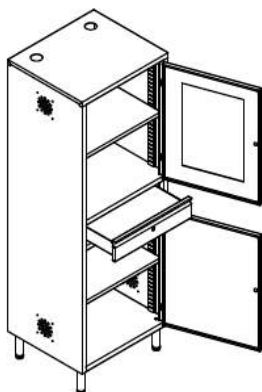

mm 520 deep

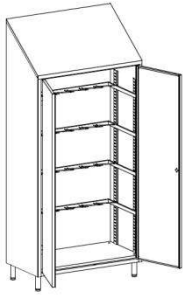

**STORAGE CUPBOARDS
PC CUPBOARD
BOOT STORAGE CUPBOARD**

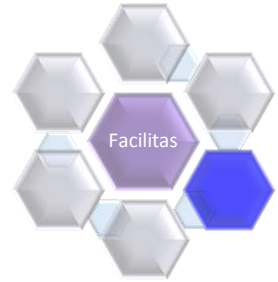

0,8 mm thick stainless steel brushed 2J finish (Scotch-Brite), dustproof slanting top, handle lock with key, adjustable boot racks, adjustable screw on feet.

BOOT STORAGE CUPBOARDS

X2025

1 door, tubes for 6 pair of boots
mm 500 x 500 x 1800 / 2160 H

X2026

2 door, tubes for 12 pair of boots
mm 950 x 500 x 1800 / 2160 H



YouTube

X2027

2 door, tubes for 16 pair of boots
mm 1200 x 500 x 1800 / 2160 H

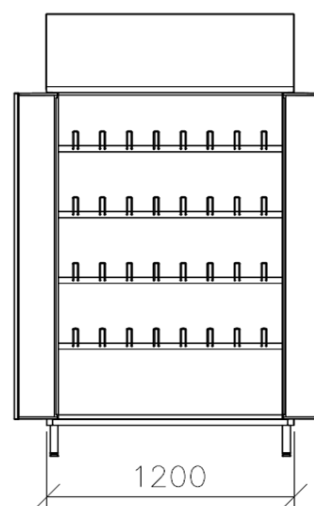
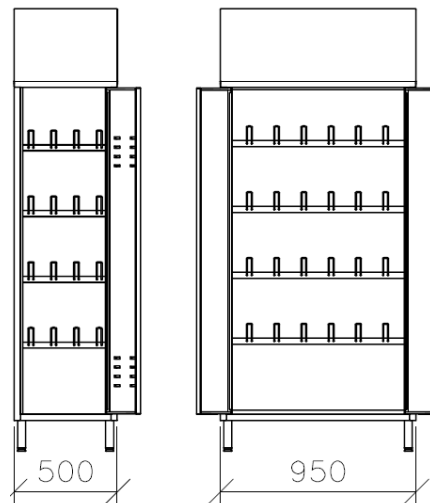

mm 500 deep



STAND-UP DESKS

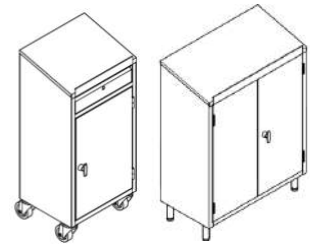

CHEST OF DRAWERS

0,8 mm thick stainless steel brushed 2J finish (Scotch-Brite), inclined writing top with pen stop, with or without drawer, doors and drawer closed with key lock, adjustable screw on feet or on 4 wheels (front 2 with breaks).

STAND-UP DESKS- STANDARD

X40650

1 door, 1 drawer, with feet
mm 500 x 400 x 1170 H

X4010

1 door, 1 drawer, with wheels
mm 500 x 400 x 1170 H

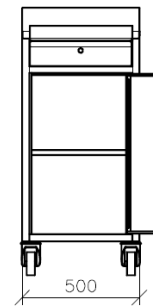
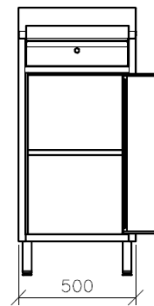

X40590

2 doors, 1 drawer, with feet
mm 800 x 400 x 1170 H

X4030

2 doors, 1 drawer, with wheels
mm 800 x 400 x 1170 H

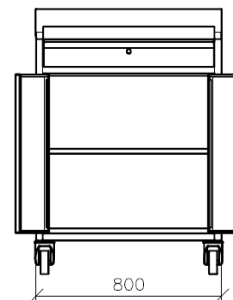
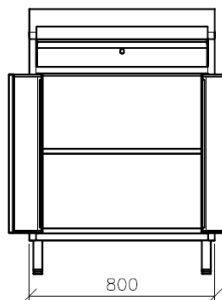

X4006

1 door, 2 shelves, with feet
mm 500 x 400 x 1170 H

X4040

1 door, 2 shelves, with wheels
mm 500 x 400 x 1170 H

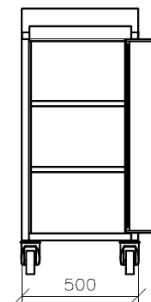
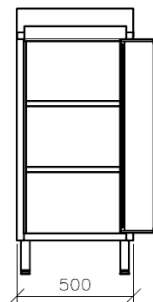

X4005

2 doors, 2 shelves, with feet
mm 800 x 400 x 1170 H

X4020

2 doors, 2 shelves, with wheels
mm 800 x 400 x 1170 H

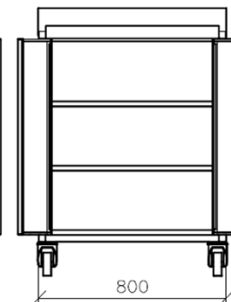
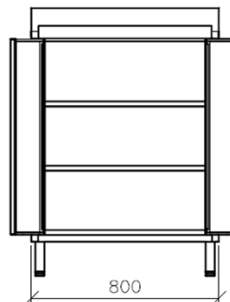

mm 400 deep



STAND-UP DESKS



CHEST OF DRAWERS

Tubular pedestal structure 40 x 40 mm with 0,8 mm thick stainless steel brushed 2J finish (Scotch-Brite), inclined writing top with pen stop.
Non-lockable lid or drawer closed with key lock, adjustable feet.

STAND-UP DESKS- ECO

X4101

For wall mounting, non-lockable lid
mm 500 x 400 x 280 H

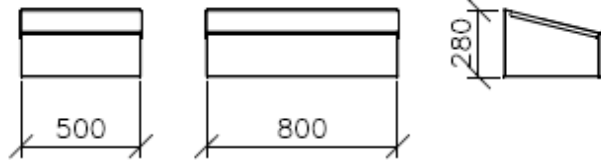

X4102

For wall mounting, non-lockable lid
mm 800 x 400 x 280 H

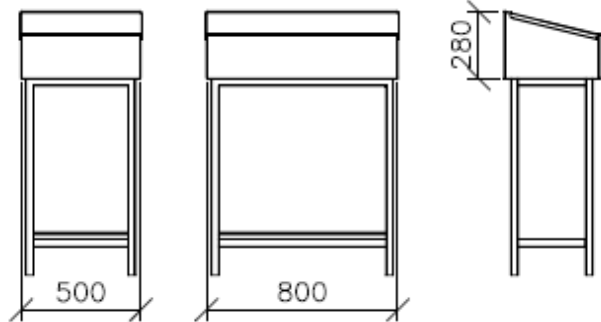

X4103

On pedestal, non-lockable lid
mm 500 x 400 x 1150 H

X4104

On pedestal, non-lockable lid
mm 800 x 400 x 1150 H

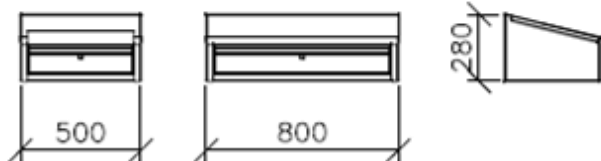

X4105

For wall mounting, 1 drawer
mm 500 x 400 x 280 H

X4106

For wall mounting, 1 drawer
mm 800 x 400 x 280 H

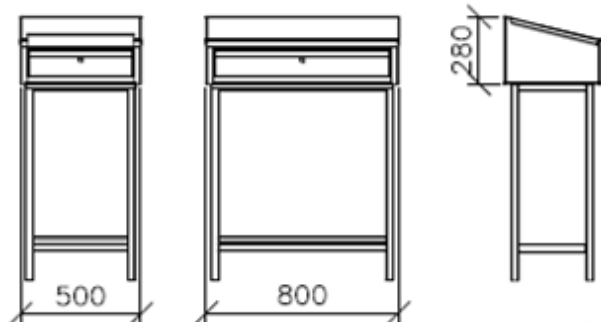

X4107

On pedestal, 1 drawer
mm 500 x 400 x 1150 H

X4108

On pedestal, 1 drawer
mm 800 x 400 x 1150 H

mm 400 deep



STAND-UP DESKS

CHEST OF DRAWERS



0,8 mm thick stainless steel brushed 2J finish (Scotch-Brite), dustproof slanting top, with 4, 5 or 6 drawers closed with key lock, adjustable screw on feet or on 4 wheels (front 2 with breaks) as an option.

CHEST OF DRAWERS – STANDARD

X4150

4 drawers with key lock
mm 500 x 400 x 1170 H

X4250

5 drawers with key lock
mm 500 x 400 x 1360 H

X4350

6 drawers with key lock
mm 500 x 400 x 1570 H

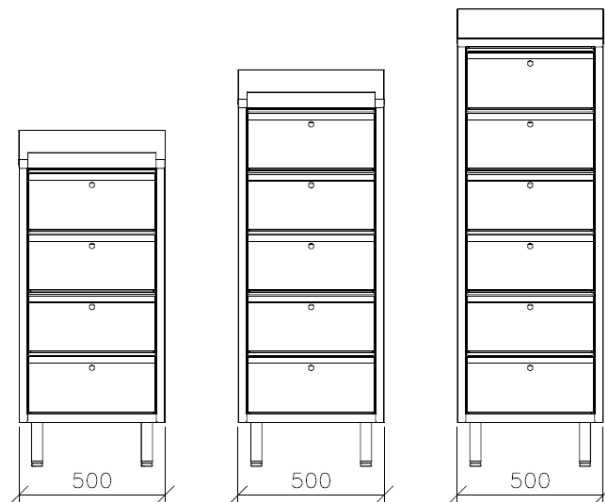

X4180

4 drawers with key lock
mm 800 x 400 x 1170 H

X4280

5 drawers with key lock
mm 800 x 400 x 1360 H

X4380

6 drawers with key lock
mm 800 x 400 x 1570 H



mm 400 deep

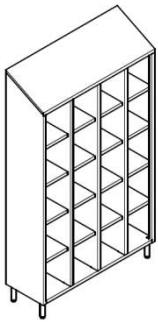

PIGEONHOLE LOCKERS
SIT-OVER PIGEONHOLE BENCHES
STAND-ALONE BENCHES



0,8 mm thick stainless steel brushed 2J finish (Scotch-Brite), dustproof slanting top, adjustable screw on feet.

PIGEONHOLE LOCKERS – WITHOUT DOORS

X4007/05-01

1 column, 5 compartments
 mm 325 x 400 x 1950 / 2160 H

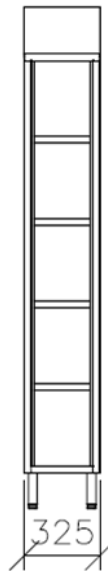

X4007/10-01

2 columns, 10 compartments
 mm 615 x 400 x 1950 / 2160 H

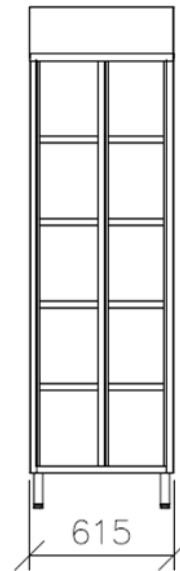

X4007/15-01

3 columns, 15 compartments
 mm 910 x 400 x 1950 / 2160 H

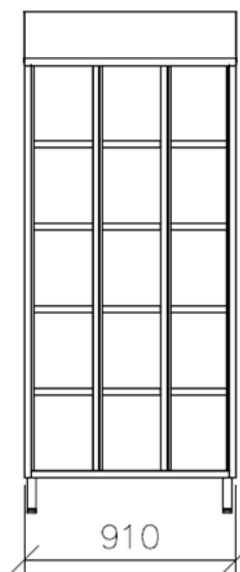

X4007/20-01

4 columns, 20 compartments
 mm 1200 x 400 x 1950 / 2160 H

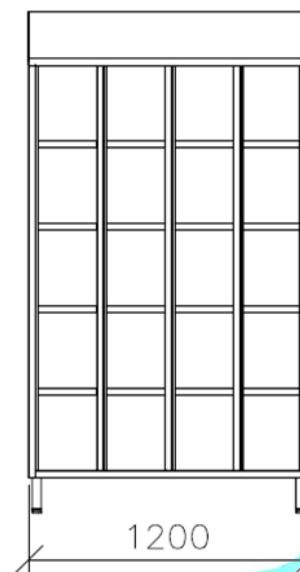

mm 400 deep

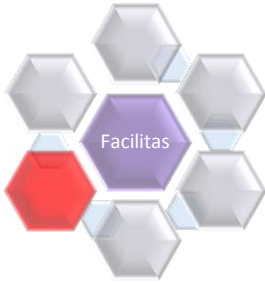

PIGEONHOLE LOCKERS
SIT-OVER PIGEONHOLE BENCHES
STAND-ALONE BENCHES

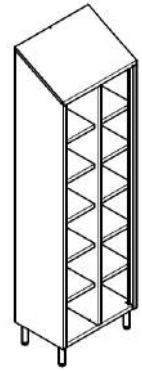

0,8 mm thick stainless steel brushed 2J finish (Scotch-Brite), dustproof slanting top, adjustable screw on feet.

PIGEONHOLE LOCKERS – WITHOUT DOORS

Clothes mm 300
 Clothes mm 300
 Shoos mm 195

X4007/06-01
 1 column, 6 compartments
 mm 325 x 400 x 1950 / 2160 H

X4007/12-01
 2 columns, 12 compartments
 mm 615 x 400 x 1950 / 2160 H

X4007/18-01
 3 columns, 18 compartments
 mm 910 x 400 x 1950 / 2160 H

X4007/24-01
 4 columns, 24 compartments
 mm 1200 x 400 x 1950 / 2160 H

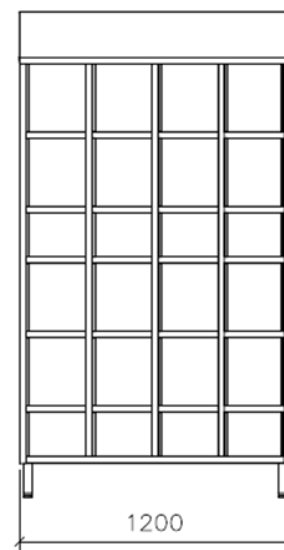
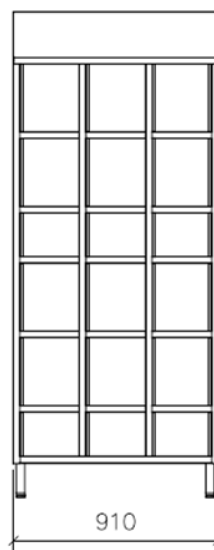
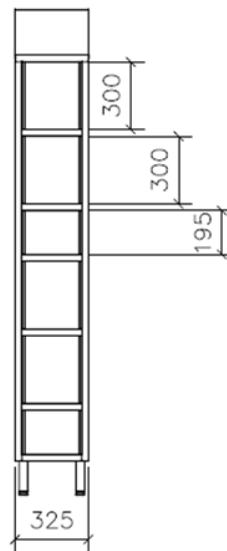

mm 400 deep

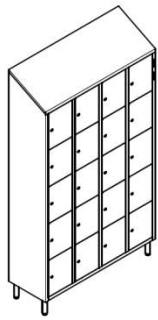

**PIGEONHOLE LOCKERS
SIT-OVER PIGEONHOLE BENCHES
STAND-ALONE BENCHES**



0,8 mm thick stainless steel brushed 2J finish (Scotch-Brite), dustproof slanting top, padlockable knob or key lock, doors with ventilation slots, adjustable screw on feet.

PIGEONHOLE LOCKERS – WITH DOORS

X4007/05-02

1 column, 5 doors

mm 325 x 400 x 1950 / 2160 H

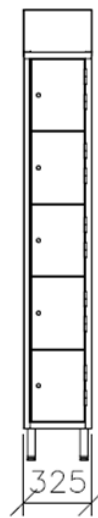

X4007/10-02

2 columns, 10 doors

mm 615 x 400 x 1950 / 2160 H

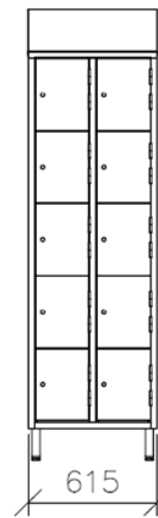

X4007/15-02

3 columns, 15 doors

mm 910 x 400 x 1950 / 2160 H

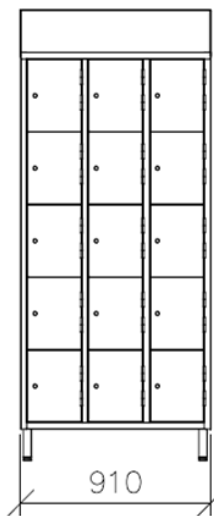

X4007/20-02

4 columns, 20 doors

mm 1200 x 400 x 1950 / 2160 H

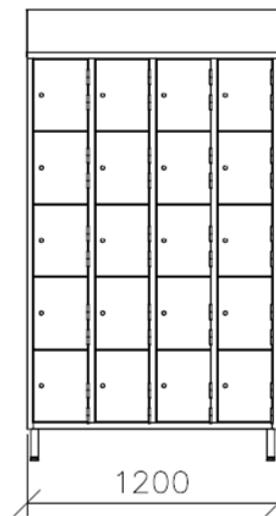

YouTube

mm 400 deep

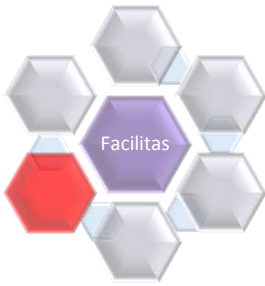

PIGEONHOLE LOCKERS
SIT-OVER PIGEONHOLE BENCHES
STAND-ALONE BENCHES

0,8 mm thick stainless steel brushed 2J finish (Scotch-Brite), dustproof slanting top, padlockable knob or key lock, adjustable screw on feet.
 1 main tubular frame door and 4, 6, 8, 10, 12 sub doors.

PIGEONHOLE CLEAN CLOTHES DISTRIBUTION LOCKERS

X4000-4

1 column, 1 + 4 doors
 mm 400 x 400 x 1800 / 2160 H

X4000-6

1 column, 1 + 6 doors
 mm 400 x 400 x 1800 / 2160 H

X4000-8

1 column, 1 + 8 doors
 mm 400 x 400 x 1800 / 2160 H

X4000-10

1 column, 1 + 10 doors
 mm 400 x 400 x 1800 / 2160 H

X4000-12

1 column, 1 + 12 doors
 mm 400 x 400 x 1800 / 2160 H

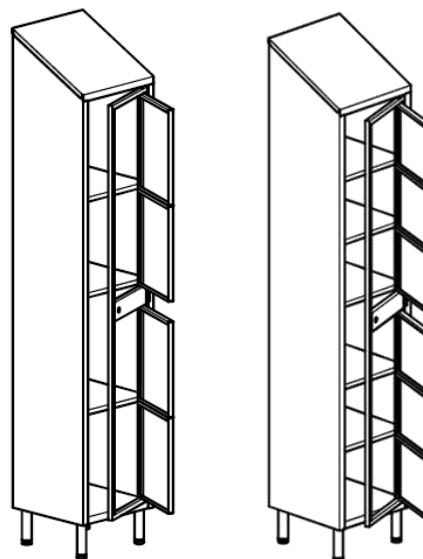
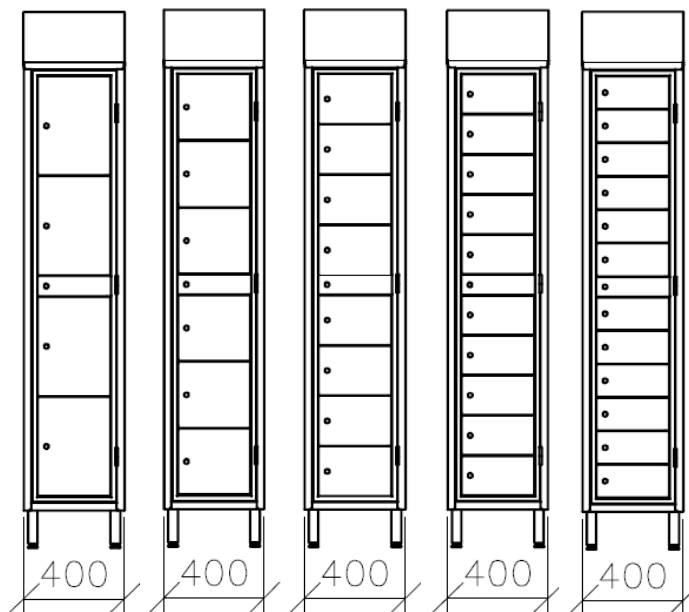

mm 400 deep

**PIGEONHOLE LOCKERS
SIT-OVER PIGEONHOLE BENCHES
STAND-ALONE BENCHES**



1,0 mm thick stainless steel brushed 2J finish (Scotch-Brite) structure, strengthened base board. Reinforced stainless steel seat or food grade white polyethylene seat. Pigeonholes for shoe storage.

REINFORCED STAINLESS STEEL SEAT or WHITE POLYETHYLENE SEAT

X7005
X7005PE (polyethylene)
1 side with 6 compartments
mm 1000 x 300 x 525 H

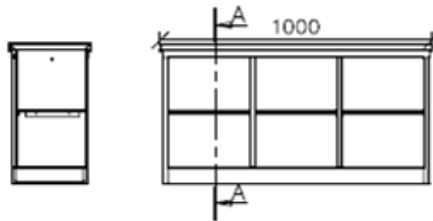

X7006
X7006PE PE (polyethylene)
2 sided with 6+6 compartments
mm 1000 x 600 x 525 H

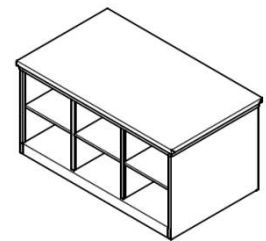
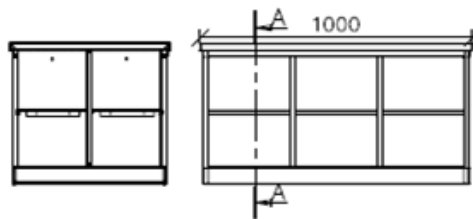

X7007
X7007PE (polyethylene)
1 side with 12 compartments
mm 2000 x 300 x 525 H

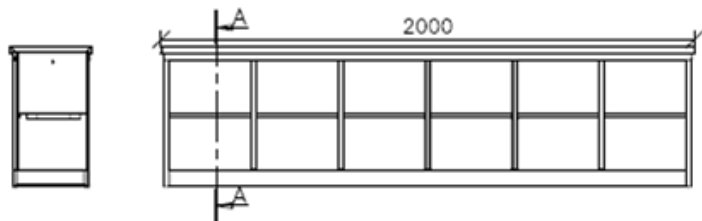

X7008
X7008 PE (polyethylene)
2 sided with 12+12 compartments
mm 2000 x 600 x 525 H

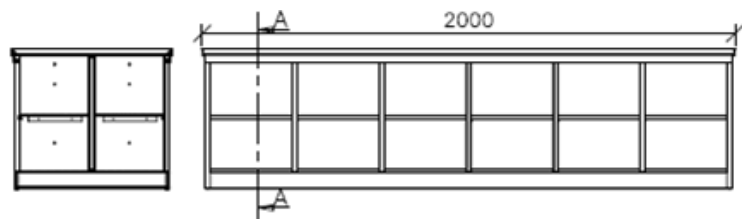

mm 300 - 600 deep



PIGEONHOLE LOCKERS
SIT-OVER PIGEONHOLE BENCHES
STAND-ALONE BENCHES



0,8 mm thick stainless steel brushed 2J finish (Scotch-Brite), inclined writing top with pen stop, with or without drawer, doors and drawer closed with key lock, adjustable screw on feet or on 4 wheels (front 2 with breaks).

CHEST OF DRAWERS – STANDARD

X4190
 4 drawers with key lock
 mm 800 x 600 x 1100 H

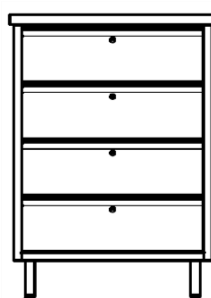

mm 600 deep

LOW PIGEONHOLE LOCKER – WITH DOORS

X4007/6
 3 columns, 6 doors
 mm 800 x 400 x 1170 H

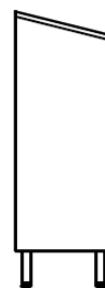
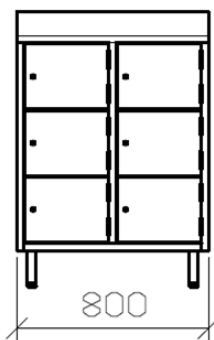

mm 400 deep

PIGEONHOLE LOCKERS
SIT-OVER PIGEONHOLE BENCHES
STAND-ALONE BENCHES



40 x 40 mm stainless steel structure, reinforced 1.0 mm stainless steel seat.
Adjustable feet.

STAND-ALONE BENCH

X7001

4 legs

mm 1000 x 400 x 450 H

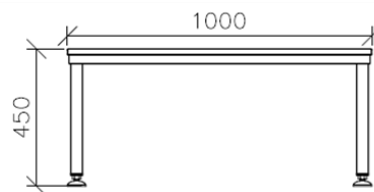

X7002

4 legs

mm 1500 x 400 x 450 H

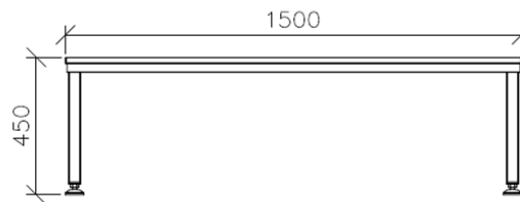

X7003

4 legs

mm 2000 x 400 x 450 H

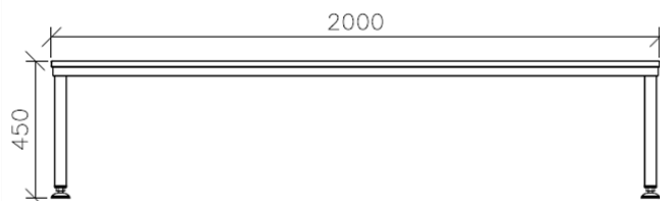

mm 400 deep



SLIDING DOOR STORAGE CUPBOARDS DISPENSERS



1,0 mm thick stainless steel brushed 2J finish (Scotch-Brite) structure, sliding doors closed with push-in key lock, adjustable shelves on stainless steel pegs, adjustable fixed feet. Lockers 1600 mm wide with internal vertical partition.

DUSTPROOF SLANTING TOP

4 adjustable shelves

X6001	950 x 400 x 2160 H
X6002	950 x 500 x 2160 H
X6003	950 x 600 x 2160 H
X6004	950 x 700 x 2160 H
X6005	950 x 800 x 2160 H
X6006	1200 x 400 x 2160 H
X6007	1200 x 500 x 2160 H
X6008	1200 x 600 x 2160 H
X6009	1200 x 700 x 2160 H
X6010	1200 x 800 x 2160 H
X6011	1400 x 400 x 2160 H
X6012	1400 x 500 x 2160 H
X6013	1400 x 600 x 2160 H
X6014	1400 x 700 x 2160 H
X6015	1400 x 800 x 2160 H

4+4 adjustable shelves with vertical partition

X6016	1600 x 400 x 2160 H
X6017	1600 x 500 x 2160 H
X6018	1600 x 600 x 2160 H
X6019	1600 x 700 x 2160 H
X6020	1600 x 800 x 2160 H
X6021	1800 x 400 x 2160 H
X6022	1800 x 500 x 2160 H
X6023	1800 x 600 x 2160 H
X6024	1800 x 700 x 2160 H
X6025	1800 x 800 x 2160 H
X6026	1950 x 400 x 2160 H
X6027	1950 x 500 x 2160 H
X6028	1950 x 600 x 2160 H
X6029	1950 x 700 x 2160 H
X6030	1950 x 800 x 2160 H

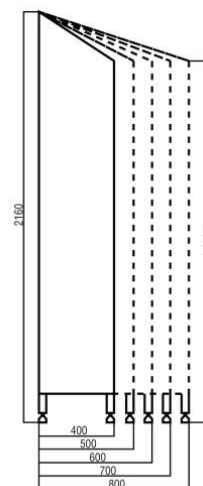
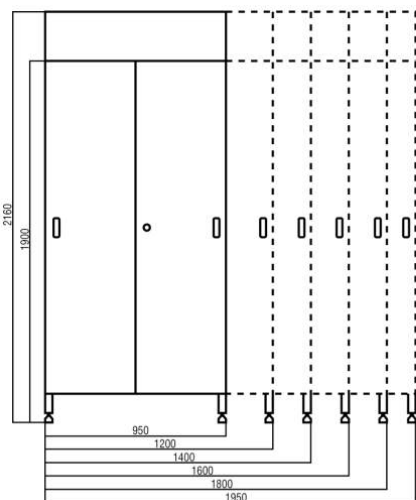

SLIDING DOOR STORAGE CUPBOARDS DISPENSERS



1,0 mm thick stainless steel brushed 2J finish (Scotch-Brite) structure, sliding doors closed with push-in key lock, adjustable shelves on stainless steel pegs, adjustable fixed feet. Lockers 1600 mm wide with internal vertical partition.

FLAT TOP

4 adjustable shelves

X6031	950 x 400 x 1900 H
X6032	950 x 500 x 1900 H
X6033	950 x 600 x 1900 H
X6034	950 x 700 x 1900 H
X6035	950 x 800 x 1900 H
X6036	1200 x 400 x 1900 H
X6037	1200 x 500 x 1900 H
X6038	1200 x 600 x 1900 H
X6039	1200 x 700 x 1900 H
X6040	1200 x 800 x 1900 H
X6041	1400 x 400 x 1900 H
X6042	1400 x 500 x 1900 H
X6043	1400 x 600 x 1900 H
X6044	1400 x 700 x 1900 H
X6045	1400 x 800 x 1900 H

4+4 adjustable shelves with vertical partition

X6046	1600 x 400 x 1900 H
X6047	1600 x 500 x 1900 H
X6048	1600 x 600 x 1900 H
X6049	1600 x 700 x 1900 H
X6050	1600 x 800 x 1900 H
X6051	1800 x 400 x 1900 H
X6052	1800 x 500 x 1900 H
X6053	1800 x 600 x 1900 H
X6054	1800 x 700 x 1900 H
X6055	1800 x 800 x 1900 H
X6056	1950 x 400 x 1900 H
X6057	1950 x 500 x 1900 H
X6058	1950 x 600 x 1900 H
X6059	1950 x 700 x 1900 H
X6060	1950 x 800 x 1900 H

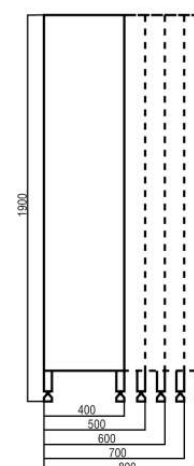
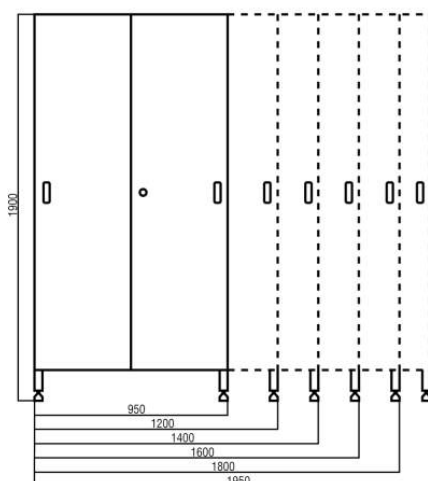



SLIDING DOOR STORAGE CUPBOARDS DISPENSERS

0,8 mm thick stainless steel brushed 2J finish (Scotch-Brite) structure, ready for wall mounting

FOR WALL MOUNTING

D001 – universal dispenser
mm 270 x 230 x 350 H

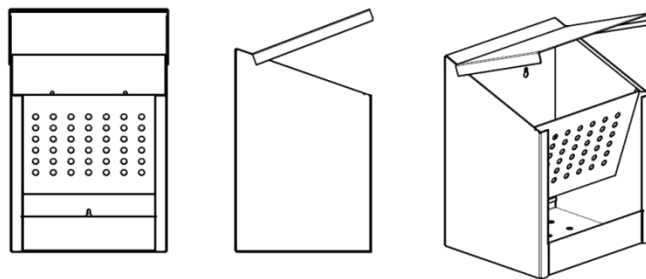

D009 – universal dispenser
mm 300 x 220 x 400 H

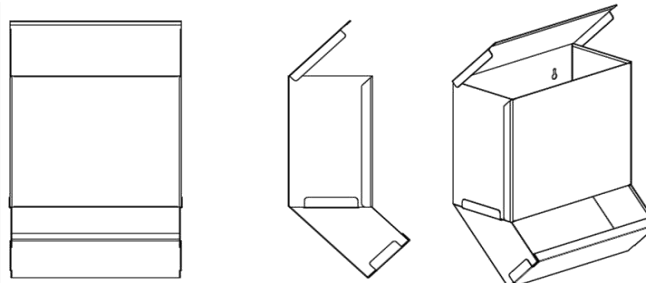

D005 – trash bin
mm 370 x 280 x 420 H

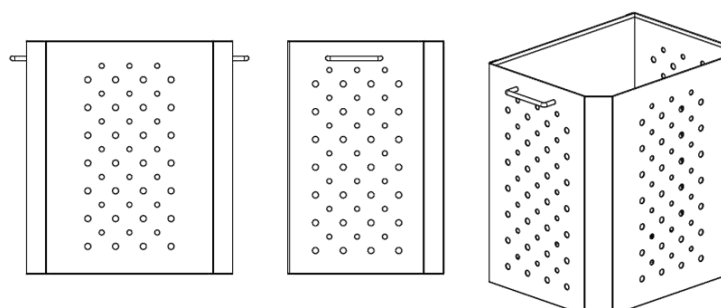

D006 – document holder
mm 250 x 140 x 280 H

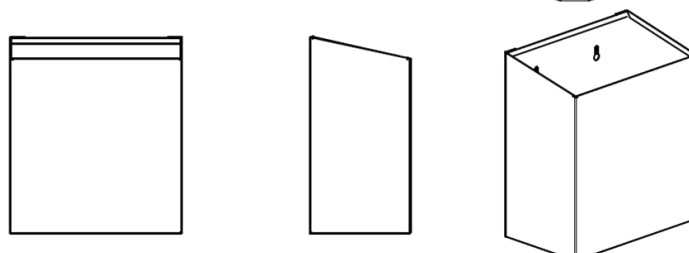

SLIDING DOOR STORAGE CUPBOARDS DISPENSERS



0,8 mm thick stainless steel brushed 2J finish (Scotch-Brite) structure, ready for wall mounting

FOR WALL MOUNTING

D010 – medical supplies
mm 600 x 200 x 700 H

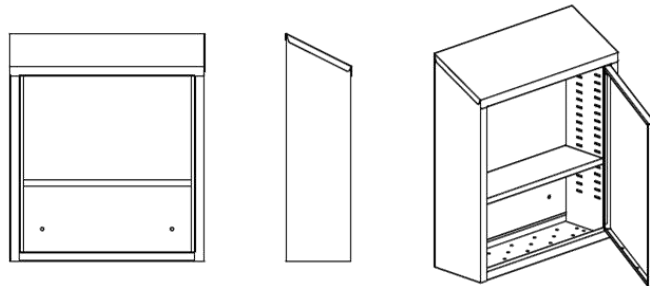

D003 – paper roll 300 dispenser
mm 375 x 350 x 440 H

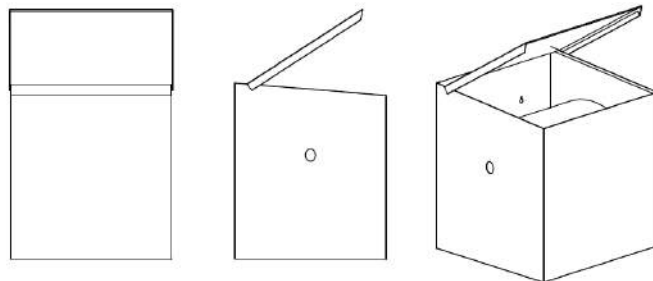

D004 – paper roll 250 dispenser
mm 270 x 250 x 300 H

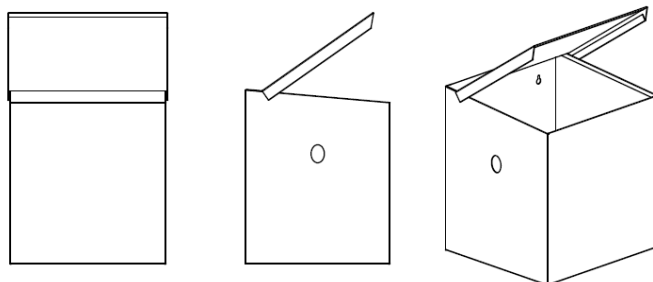

A61-DA – coat hanger 5 nylon hooks
mm 1000 x 20 x 105 H

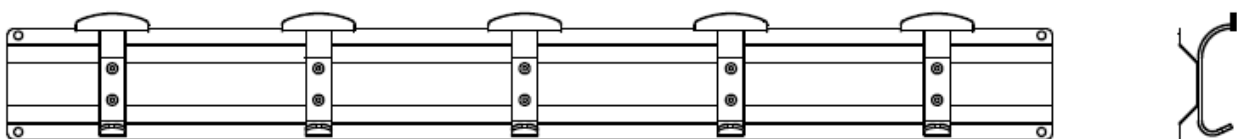

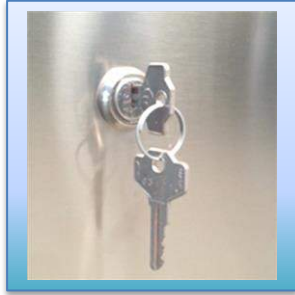



ITALIAN QUALITY

STAINLESS STEEL
LOCKERS AND CUPBOARDS
FOR THE FOOD INDUSTRY

FACILITAS SRL

Via Lazio, 7

I-41050 Montale Rangone (Modena) - ITALY

Tel.: +39 (0)59 530.570

Fax: +39 (0)59 490.9000

Email: facilitas@facilitas.it

Web: www.facilitas.it

